

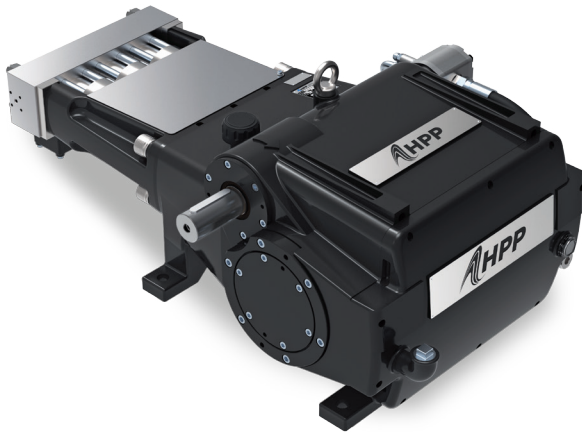

# H-200 SAP



## LEGEND

 With tungsten carbide plunger

 With forced lubrication















 Heat exchanger

 Vertical assembling

 Horizontal assembling

## SAP SERIES UP TO 1500 BAR

 H-200 SAP   

 IV GENERATION	 IV GENERATION													
Code	Code	Ø mm	rpm	gear ratio	rpm	l/min	USgpm	bar	psi	MPa	HP	kW	kg	lb
P232052V14220	P232052H14220	22	1500	3,14	478	54,5	14,4	1470	21315	147	201,8	148,4	500	1103
P232062V14220	P232062H14220		1800	3,79	475	54,1	14,3	1470	21315	147	200,4	147,4	500	1103
P232052V14240	P232052H14240	24	1500	3,14	478	64,9	17,1	1300	18850	130	212,4	156,2	500	1103
P232062V14240	P232062H14240		1800	3,79	475	64,4	17,0	1300	18850	130	210,9	155,1	500	1103
P232052V14260	P232052H14260	26	1500	3,14	478	76,1	20,1	1200	17400	120	230,1	169,2	500	1103
P232062V14260	P232062H14260		1800	3,79	475	75,6	20,0	1200	17400	120	228,5	168,0	500	1103
P232052V14280	P232052H14280	28	1500	3,14	478	88,3	23,3	1000	14500	100	222,3	163,5	500	1103
P232062V14280	P232062H14280		1800	3,79	475	87,7	23,2	1000	14500	100	220,8	162,4	500	1103
P232052V14300	P232052H14300	30	1500	3,14	478	101,4	26,8	800	11600	80	204,2	150,2	500	1103
P232062V14300	P232062H14300		1800	3,79	475	100,7	26,6	800	11600	80	202,8	149,2	500	1103
P232052V14320	P232052H14320	32	1500	3,14	478	115,3	30,5	700	10150	70	203,3	149,5	500	1103
P232062V14320	P232062H14320		1800	3,79	475	114,5	30,3	700	10150	70	201,9	148,5	500	1103
P232052V14350	P232052H14350	35	1500	3,14	478	138,0	36,5	600	8700	60	208,5	153,3	500	1103
P232062V14350	P232062H14350		1800	3,79	475	137,0	36,2	600	8700	60	207,0	152,3	500	1103
P232052V14400	P232052H14400	40	1500	3,14	478	180,2	47,6	450	6525	45	204,2	150,2	500	1103
P232062V14400	P232062H14400		1800	3,79	475	179,0	47,3	450	6525	45	202,8	149,2	500	1103

# DIMENSIONS

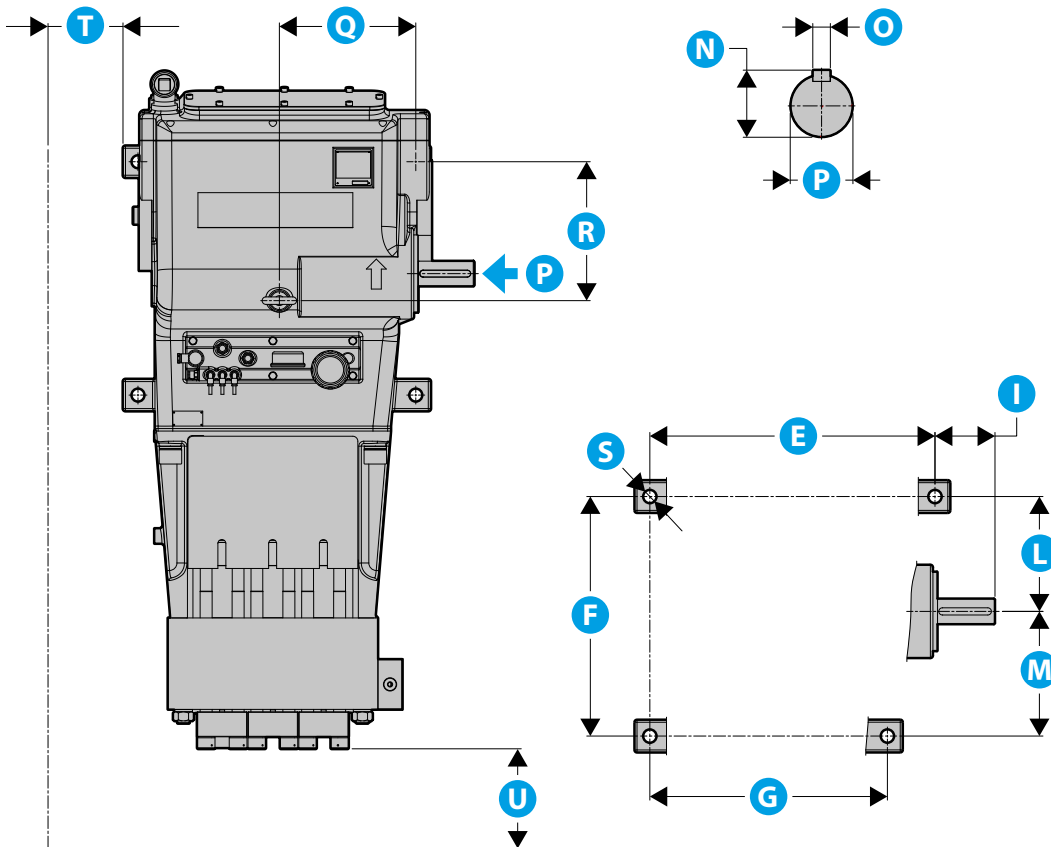
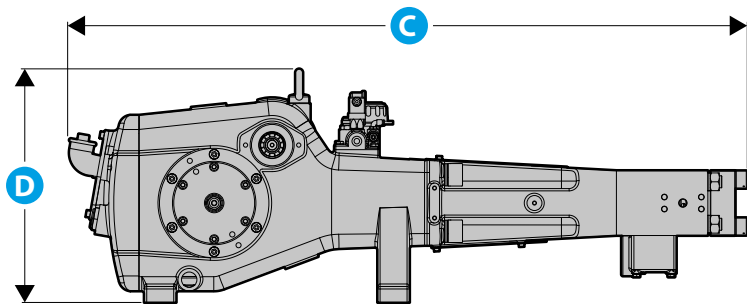
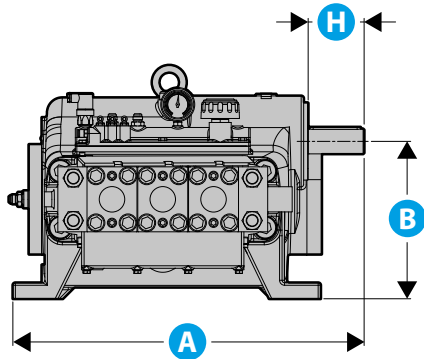

Pump Model		H-200 SAP
A	mm	703
	(in)	(27,68)
B	mm	315
	(in)	(12,40)
C	mm	1220
	(in)	(48,03)
D	mm	467,5
	(in)	(18,41)
E	mm	556
	(in)	(21,89)
F	mm	467
	(in)	(18,39)
G	mm	556
	(in)	(21,89)
H	mm	112
	(in)	(4,41)
I	mm	117
	(in)	(4,61)
L	mm	224
	(in)	(8,82)
M	mm	243
	(in)	(9,57)
N	mm	53,5
	(in)	(2,11)
O	mm	14 (DIN 6885)
	(in)	(0,55)
P	mm	ø 50 +0,018 +0,002
	(in)	(ø 1,97)
Q	mm	273
	(in)	(10,75)
R	mm	278
	(in)	(10,94)
S	mm	ø 26
	(in)	(ø 1,02)
T	mm	150
	(in)	(5,91)
U	mm	500
	(in)	(19,69)

## PUMP ACCESSORIES

REGULATING VALVES



PNEUMATIC CONTROL VALVES

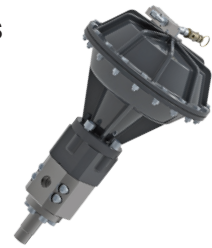

SAFETY VALVES



PRESSURE GAUGES



## ACCESSORIES FOR WORK

DUMP SHUT GUNS / UNDERWATER GUNS / PNEUMATIC GUNS



DUMP TYPE FOOT VALVE

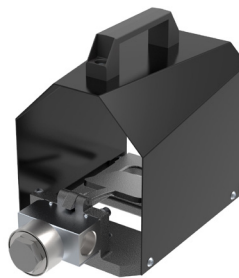

MULTI-JET

Multi-purpose surface. Preparation system for floors and hulls. 2800 bar (40K psi).



POWER BOX

3/2" Ultra High Pressure control valve to control the gun's water flow and/or operate with a multi-gun system.

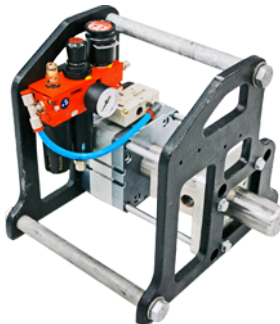

HIGH PRESSURE HOSES  
ULTRA HIGH PRESSURE HOSES



FLEXIBLE LANCE NOZZLES  
RIGID LANCE NOZZLES



HIGH PRESSURE SWIVEL FOR HOSES



ROTATING NOZZLES



PROTECTIVE CLOTHING FOR WATERJETTING (TST)



FLEXIBLE LANCES / RIGID LANCES



"TURBO" NOZZLES





Distributed by: / Distribuito da:

**P.T.C. Srl** › via Mantegna, 4 - 42048 Rubiera (RE) - Italy

Phone: +39 0522/1932911 › Fax: +39 0522/1932922

mail: [info@ptcitaliana.com](mailto:info@ptcitaliana.com) › website: [www.ptcitaliana.com](http://www.ptcitaliana.com)

---